

**Industrial L3 Rack-mount
Managed Ethernet Switch**

IGS-6325 Series

Quick Installation Guide

Table of Contents

1. Package Contents	3
2. Requirements	4
3. Wiring DC Power Inputs	5
4. Terminal Setup	6
4.1 Logging into the Console	7
4.2 Configuring IP Address via Console	9
5. Starting Web Management	11
5.1 Logging in to the Industrial Managed Switch	12
5.2 Saving Configuration via Web	15
6. Returning to Default Configuration	17
7. Customer Support	18

1. Package Contents

Thank you for purchasing PLANET Industrial L3 Managed Ethernet Switch. **"Industrial Managed Switch"** is used as an alternative name in this Quick Installation Guide.

Open the box of the Industrial Managed Switch and carefully unpack it. The box should contain the following items for each model:

	IGS-6325-20T4C4X	IGS-6325-20S4C4X	IGS-6325-24P4X	IGS-6325-24P4S	IGS-6325-24UP4X
Quick Installation Guide	■	■	■	■	■
DB9 to RJ45 Interface RS232 Console Cable	■	■	■	■	■
Rack-mount Accessory Kit	■	■	■	■	■
AC Power Cord	■	■	-	-	-
RJ45 Dust Cap	25	5	25	25	25
SFP Dust Cap	8	28	8	4	4

If any item is found missing or damaged, please contact your local reseller for replacement.

2. Requirements

The Industrial Managed Switch provides a remote login interface for management purposes. The following equipment is necessary for further management:

- Workstations running Windows 10/11, MAC OS 10.15 or later, Linux, UNIX, or other platforms are compatible with TCP/IP protocols.
- Workstations are installed with Ethernet NIC (Network Interface Card)
- **Serial Port Connection** (Terminal)
 - The above Workstations come with COM Port (DB9) or USB-to-RS232 converter.
 - The above Workstations have been installed with terminal emulator, such as putty or Tera Term, etc.
 - Serial Cable -- Connect one end of the serial cable to the RS232 serial port, and the other end to the console port of the Industrial Managed Switch.
- **Ethernet Port Connection**
 - Network cables -- Use standard network (UTP) cables with RJ45 connectors.
 - The above PC is installed with Web browser.



Note

It is recommended to use a modern browser, such as Google Chrome, Mozilla Firefox, or Microsoft Edge, to access the Industrial Managed Switch. If the Web interface of the Industrial Managed Switch is not accessible, please turn off the anti-virus software or firewall and then try it again.

3. Wiring DC Power Inputs

The 6-contact terminal block connector on the panel of Industrial Managed Switch is used for two DC redundant power inputs. Please follow the steps below to insert the power wires.

1. Insert positive and negative DC power wires into contacts 1 and 2 for DC POWER 1, or 5 and 6 for DC POWER 2.

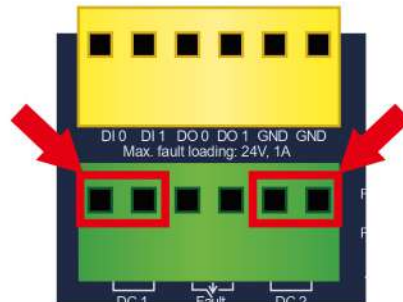

Figure 3-1: 6-contact terminal block connector of IGS-6325-20T4C4X and IGS-6325-20S4C4X

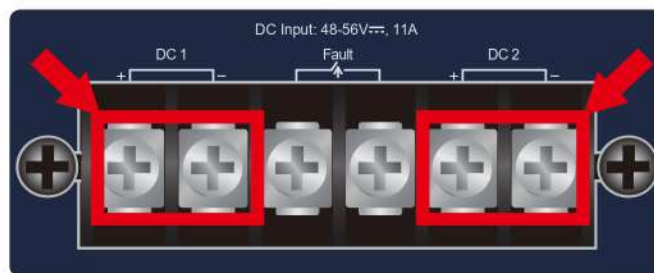

Figure 3-2: 6-contact barrier terminal block of IGS-6325-24P4X, IGS-6325-24P4S, IGS-6325-24UP4X

2. Tighten the wire-clamp screws to prevent the wires from loosening.

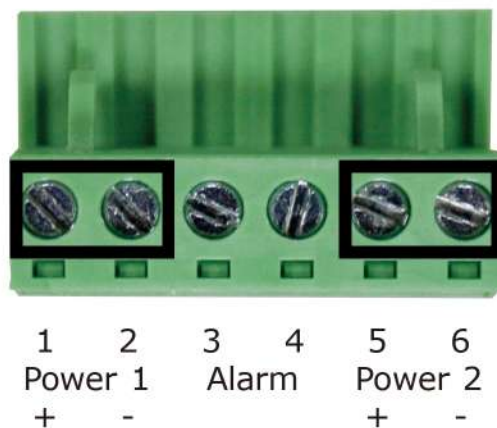

Figure 3-3: The screws of 6-contact terminal block connector



Note

The wire gauge of the terminal block should be between 12 and 24 AWG.

4. Terminal Setup

To configure the system, connect a serial cable from a COM port on your PC or notebook computer to the RJ45 serial port on the Industrial Managed Switch.

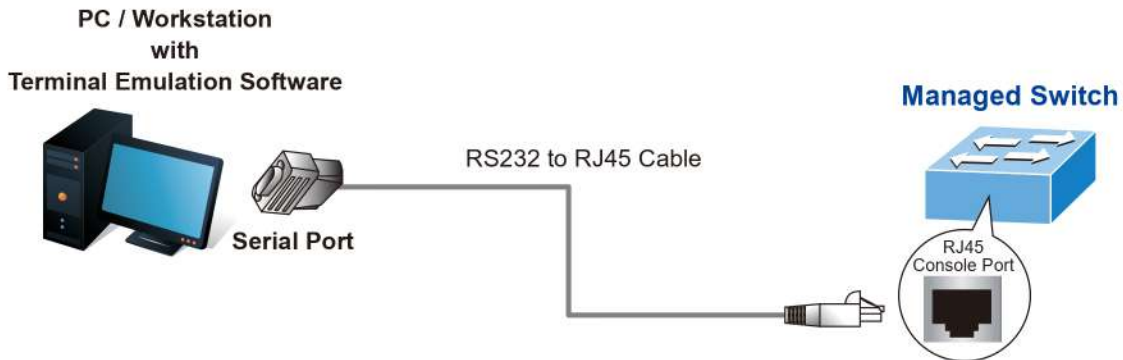

Figure 4-1: Console Connection for Industrial Managed Switch

A terminal program is required to establish a software connection to the Industrial Managed Switch.

1. Run the terminal program on your operating system.
2. When the following screen appears, ensure that the COM port is configured as follows:
 - ◆ Bits per second: 115200
 - ◆ Data bits: 8
 - ◆ Parity: None
 - ◆ Stop bits: 1
 - ◆ Flow control: None

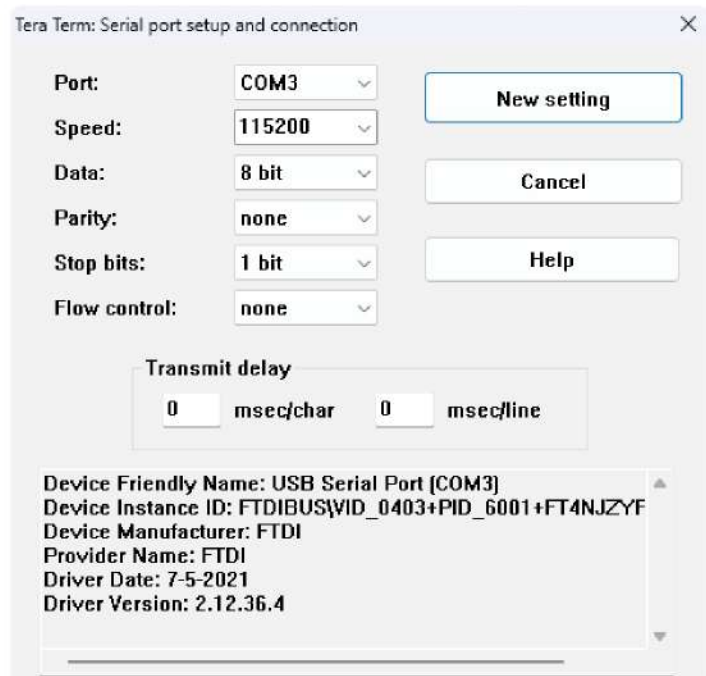

Figure 4-2: COM Port Configuration

4.1 Logging into the Console

Once the terminal is connected to the device, power on the Managed PoE Switch, and the terminal will display “running testing procedures”. Then, the following message asks to log in user name and password. The factory default user name and password are shown as follows and the login screen in Figure 4-3 appears.



IGS-6325-24UP4X is used as a representative in all the following console screens.



The following console screen is based on the firmware version before **February of 2024**.

```
Username: admin
Password: admin
```

```
Username: admin
Password:
IGS-6325-24UP4X#
```

Figure 4-3: Managed Metro Switch Console Login Screen



1. For security reason, please change and memorize the new password after this first setup.
2. Only accept command in lowercase letter under console interface.



The following console screen is based on the firmware version of **February of 2024 or after**.

Username: **admin**

Password: **sw + the last 6 characters of the MAC ID in lowercase**

Find the MAC ID on your device label. The default password is "sw" followed by the last six lowercase characters of the MAC ID.

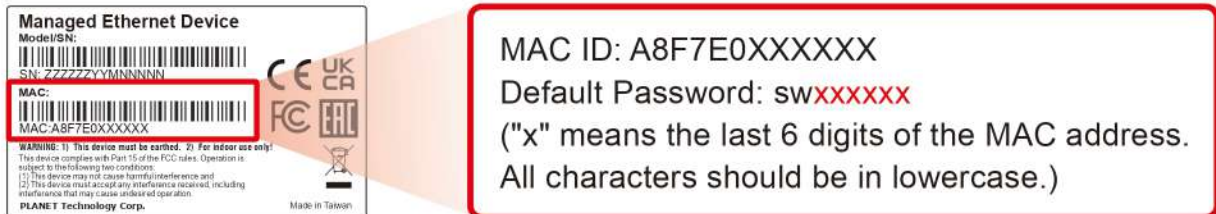

Figure 4-4: MAC ID Label

Enter the default username and password, then set a new password according to the rule-based prompt and confirm it. Upon success, press any key to return to the login prompt. Log in with "admin" and the "new password" to access the CLI.

```
(New)Password:  
Verify (New)Password:  
The password is set successfully.  
  
Press ENTER to get started  
  
Username: admin  
Password:  
IGS-6325-24UP4X#
```

Figure 4-5: Create a New Password and Login Again

The user can now enter commands to manage the Industrial Managed Switch. For a detailed description of the commands, please refer to the following chapters.

4.2 Configuring IP Address via Console

The Industrial Managed Switch is shipped with a default IP address, shown below.

```
IP Address: 192.168.0.100  
Subnet Mask: 255.255.255.0
```

To check or modify the current IP address for the Switch, follow the procedures below (IGS-6325-20T4C4X is used to demonstrate how to use the commands):

■ Show the current IP Address

1. At the “#” prompt, enter “**show ip interface brief**”.

```
IGS-6325-20T4C4X # show ip interface brief
```

2. The screen displays the current IP address, as shown in Figure 4-6.

Interface	Address	Method	Status
VLAN 1	192.168.0.100/24	Manual	UP

Figure 4-6: IP Information Screen

■ Configuring IP Address

3. At the “#” prompt, enter the following command and press **<Enter>** as shown in Figure 4-7.

```
IGS-6325-20T4C4X # configure terminal  
IGS-6325-20T4C4X (config) # interface vlan 1  
IGS-6325-20T4C4X (config-if-vlan) # ip address 192.168.1.100 255.255.255.0
```

The previous command would apply the following settings for the Industrial Managed Switch.

```
IP Address: 192.168.1.100  
Subnet Mask: 255.255.255.0
```

```
IGS-6325-20T4C4X# configure terminal  
IGS-6325-20T4C4X(config)# interface vlan 1  
IGS-6325-20T4C4X(config-if-vlan)# ip address 192.168.1.100 255.255.255.0  
IGS-6325-20T4C4X(config-if-vlan)#
```

Figure 4-7: IP Address Configuration Screen

4. Repeat step 1 to check if the IP address is changed.

5. Enter the following command and press **<Enter>** to go back to “#” prompt.

exit

```
IGS-6325-20T4C4X(config-if-vlan)# exit
IGS-6325-20T4C4X(config)# exit
IGS-6325-20T4C4X#
```

Figure 4-8: Exit Command

6. At the “#” prompt, enter the following command and press **<Enter>**.

copy running-config startup-config

```
IGS-6325-20T4C4X# copy running-config startup-config
Building configuration...
do not reset or power off the device!
% Saving 5364 bytes to flash:startup-config
```

Figure 4-9: Saving Current Configuration

If the IP address is successfully configured, the Industrial Managed Switch will immediately apply the new setting. You can access the web interface of the Industrial Managed Switch using the new IP address.



Note

If you're unfamiliar with the console commands or related parameters, enter **"help"** at any time in the console to get a description of available help options.

5. Starting Web Management

The following steps explain how to start up the **Web Management** of the Industrial Managed Switch. Note that the Industrial Managed Switch is configured through an Ethernet connection. Please ensure that the manager PC is set to the same **IP subnet address**.

For example, the default IP address of the Industrial Managed Switch is **192.168.0.100**. To manage the switch from a manager PC, set the PC's IP address to **192.168.0.x** (where x is a number between 1 and 254, excluding 100). The default subnet mask is 255.255.255.0.

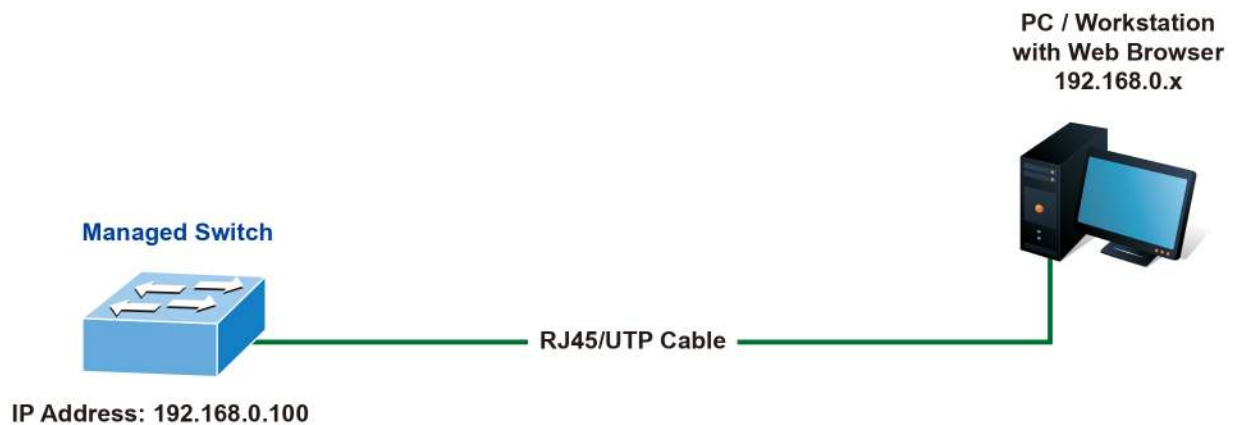
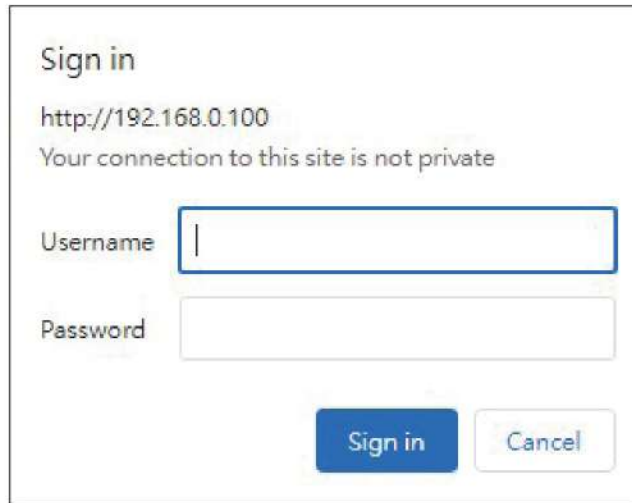

Figure 5-1: IP Management Diagram

5.1 Logging in to the Industrial Managed Switch

1. Use Google Chrome, Microsoft Edge or Firefox Web browser and enter IP address **https://192.168.0.100** to access the Web interface.
2. When the following dialog box appears, please enter the default username and password (or the password you have changed before) as shown in Figure 5-2.



Sign in

http://192.168.0.100

Your connection to this site is not private

Username

Password

Sign in Cancel

Figure 5-2: Login Screen



The following web screen is based on the firmware version before **February of 2024**.

- 2.1 When the login dialog appears, please enter the default username and password.

Default IP Address: **192.168.0.100**

Default Username: **admin**

Default Password: **admin**



The following web screen is based on the firmware version of **February of 2024 or after**.

2.2 When the following dialog box appears, please enter the default user name “**admin**” and password.

Default IP Address: **192.168.0.100**
Default Username: **admin**
Default Password: **sw + the last 6 characters of the MAC ID in lowercase**

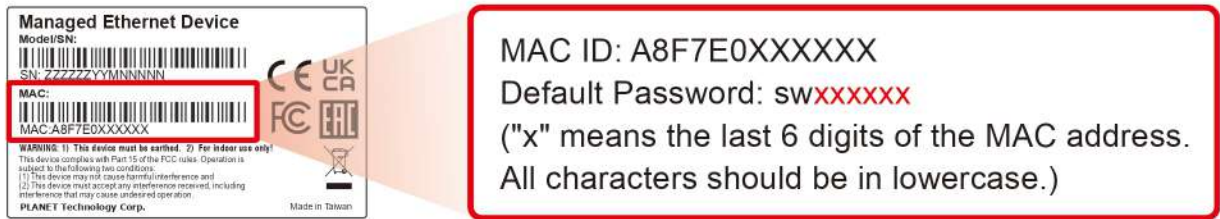

Figure 5-3: MAC ID Label

2.3 After logging in, you will be prompted to change the initial password to a permanent one.

Change Password

New Password	
Password	<input type="password"/> <input type="checkbox"/> show password
Retype Password	<input type="password"/>

The password must contain 8-31 characters, including upper case, lower case, numerals and other symbols. Please note, spaces (blanks) are not accepted.

Figure 5-4: Change Password Screen



Note

If you have already changed the password via console or web login, please use this new password to log in and skip steps 2.2 and 2.3.

3. After entering the password, the main screen appears as shown in Figure 5-5.



Figure 5-5: Main Screen of Web Interface

4. The Switch Main Menu is displayed at the top of the web page, with functions shown on the left for configuring the Industrial Managed Switch.



Figure 5-6: Switch Menu

You can now use the web management interface to continue switch management, or manage the switch using the console interface. For more information, please refer to the user manual.



Note

If you are not familiar with Switch functions or related parameters, press the **"Help"** icon at any time on the web page to get a description of the help options.

5.2 Saving Configuration via Web

In the Industrial Managed Switch, the running configuration is stored in RAM (Random Access Memory). To keep the settings you changed after a reboot, save the running configuration from RAM to FLASH by clicking the **Save Startup Config** button.

This makes the running configuration the startup configuration file, ensuring that the configuration persists after a reboot.

1. Click **Maintenance > Switch Maintenance > Save Startup Config**.



Figure 5-7: Save Startup Config



Figure 5-8: Main Menu of the Industrial Managed Switch



Figure 5-10: Main Menu & Corresponding Functions

2. Alternatively, you can click the **“Save Configuration”** button.



Figure 5-11: Save Configuration Button

3. Click the **“Save Configuration”** button to save the running configuration.



Figure 5-12: Save Configuration

6. Returning to Default Configuration

■ IP address has been changed or admin password has been forgotten –

To reset the IP address to the default value of "192.168.0.100" or reset the login password to the default value, press the hardware-based reset button on the front panel for approximately 10 seconds. After the device reboots, you can log in to the management web interface within the same subnet of 192.168.0.x.

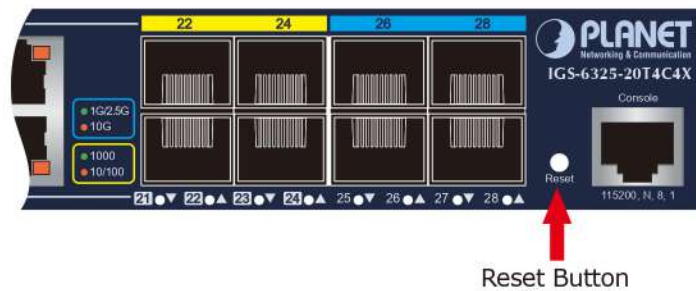

Figure 6-1: IGS-6325-20T4C4X Reset Button

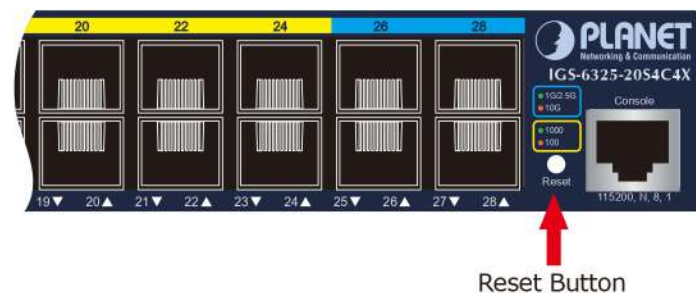

Figure 6-2: IGS-6325-20S4C4X Reset Button

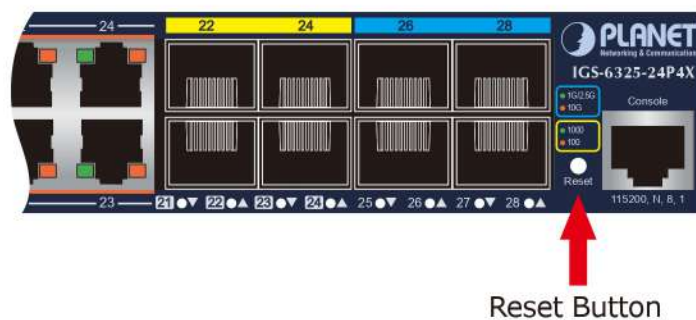

Figure 6-3: IGS-6325-24P4X and IGS-6325-24P4S Reset Button

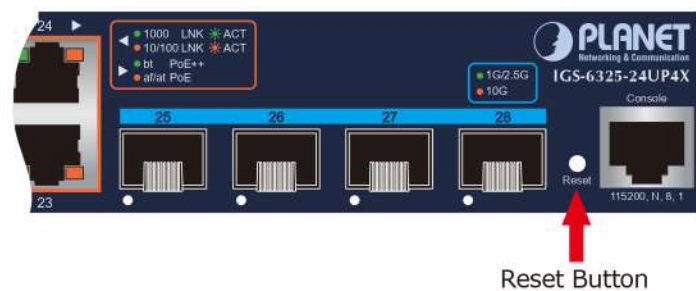

Figure 6-4: IGS-6325-24UP4X Reset Button

7. Customer Support

Thank you for purchasing PLANET products. You can browse our online FAQ resource and User's Manual on PLANET Web site first to check if it could solve your issue. If you need more support information, please contact PLANET support team.

PLANET online FAQs:

<https://www.planet.com.tw/en/support/faq>

Support team Email address:

support@planet.com.tw

IGS-6325 Series User's Manual:

<https://www.planet.com.tw/en/support/downloads?&method=keyword&keyword=IGS-6325&view=3#list>



(Please select the suitable user's manual from the list.)

Copyright © PLANET Technology Corp. 2024.

Contents are subject to revision without prior notice.

PLANET is a registered trademark of PLANET Technology Corp.

All other trademarks belong to their respective owners.